

RIR120CDM040B

1200V, 40A MPS (Merged PiN Schottky) SiC Diode

Features:

- No reverse recovery current
- Low forward voltage
- 175°C Max junction temperature
- High surge current capability
- Fast switching independent of temperature
- Pb-free, halogen free, and RoHS compliant

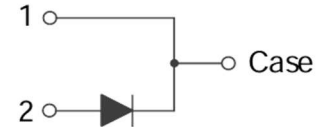
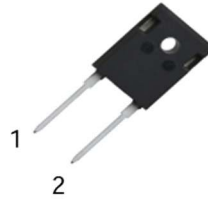

Benefits:

- System efficiency improvement
- Higher frequency applicability
- Increased power density
- Reduced cooling effort
- Lower system cost

Applications:

- Solar inverter
- EV charging station / OBC
- Power Factor Correction
- Industrial motor drive
- Induction heating / welding

Ordering Information

Part Number	Package	Shipping Media	Qualification
RIR120CDM040B	TO-247-2L	30 Units / Tube	Industrial

Absolute Maximum Ratings: $T_C = 25^\circ\text{C}$, unless otherwise specified

Parameter	Symbol	Conditions	Value	Unit
Repetitive peak reverse voltage	V_{RRM}		1200	V
Forward current	I_F	$T_C = 25^\circ\text{C}$	40	A
Non-repetitive forward surge current	$I_{F,SM}$	$T_C = 25^\circ\text{C}, t_p = 10 \text{ ms}$	225	
		$T_C = 150^\circ\text{C}, t_p = 10 \text{ ms}$	191	
Non-repetitive peak forward current	$I_{F,Max}$	$T_C = 25^\circ\text{C}, t_p = 10 \mu\text{s}$	1570	
		$T_C = 150^\circ\text{C}, t_p = 10 \mu\text{s}$	1335	
I^2dt value	$\int I^2 dt$	$T_C = 25^\circ\text{C}, t_p = 10 \text{ ms}$	253	A^2s
		$T_C = 150^\circ\text{C}, t_p = 10 \text{ ms}$	182	
Power dissipation	P_{tot}	$T_C = 25^\circ\text{C}$	556	W
Operating and storage temperature	T_J, T_{STG}		-55 to +175	$^\circ\text{C}$

Thermal Characteristics

Parameter	Symbol	Conditions	Value	Unit
Thermal resistance, junction to case, max.	$R_{\theta JC}$		0.27	$^{\circ}\text{C}/\text{W}$

Electrical Characteristics: $T_C = 25^{\circ}\text{C}$, unless otherwise specified

Parameter	Sym.	Conditions	Value			Unit
			Min.	Typ.	Max.	
Forward voltage	V_F	$I_F = 40\text{A}, T_C = 25^{\circ}\text{C}$		1.39	1.70	V
		$I_F = 40\text{A}, T_C = 175^{\circ}\text{C}$		1.8		
Reverse current	I_R	$V_R = 1200\text{V}, T_C = 25^{\circ}\text{C}$			100	μA
		$V_R = 1200\text{V}, T_C = 175^{\circ}\text{C}$			300	
Total capacitive charge	Q_C	$V_R = 800\text{V}, T_C = 25^{\circ}\text{C}$		241		nC
Total capacitance	C	$V_R = 1\text{V}, f = 100\text{ kHz}$		2638		pF
		$V_R = 800\text{V}, f = 100\text{ kHz}$		165		
Capacitance stored energy	E_C	$V_R = 800\text{V}, T_C = 25^{\circ}\text{C}$		69		μJ

Typical Performance Characteristics:

Figure 1. Power Derating

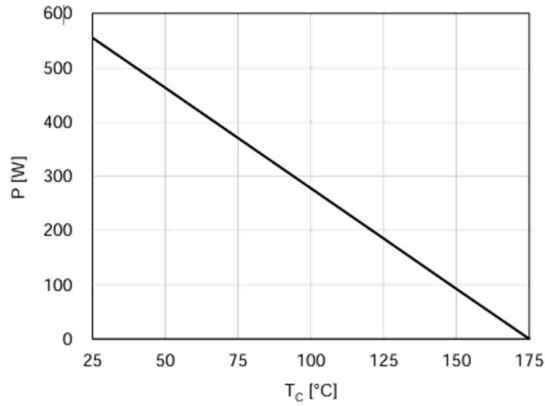

Figure 2. Current Derating

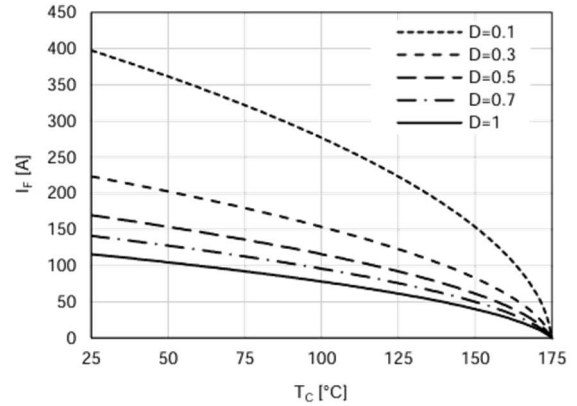

Figure 3. Forward Characteristics

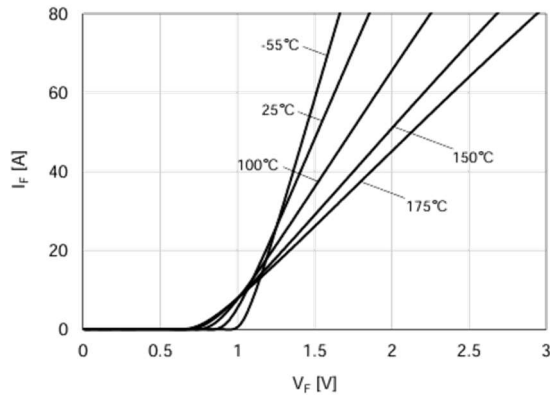

Figure 4. Reverse Characteristics

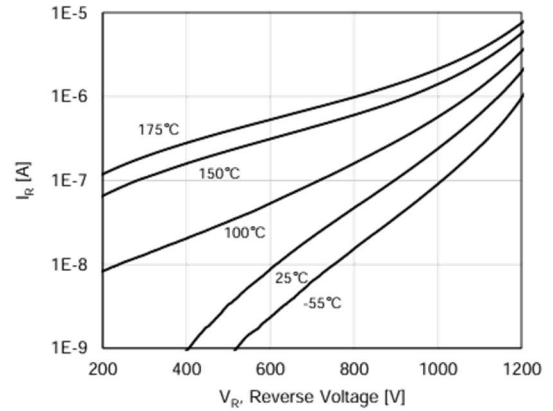

Figure 5. Capacitive Charge Characteristics

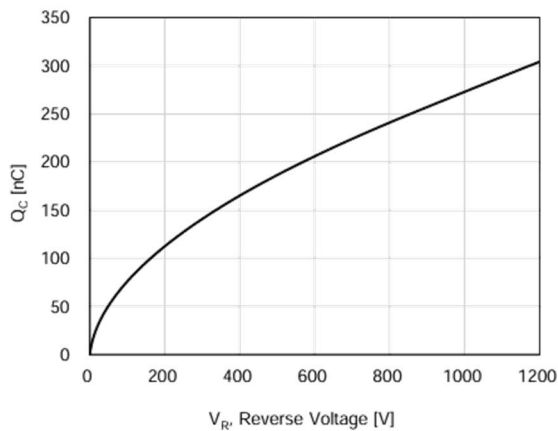

Figure 6. Capacitance Stored Energy

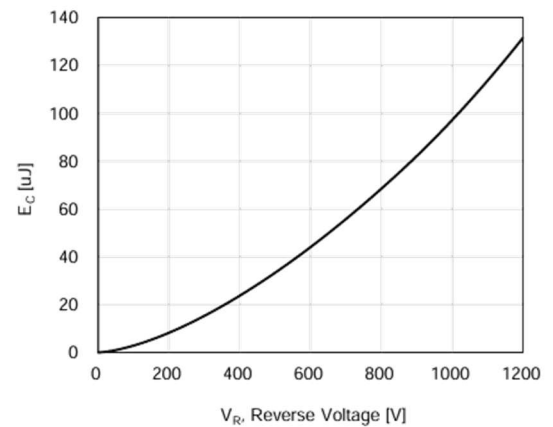

Figure 7. Capacitance Characteristics

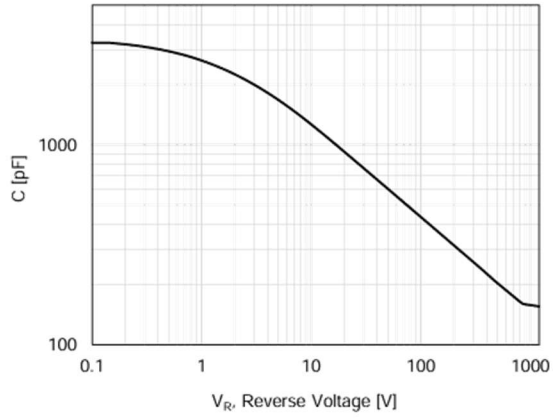
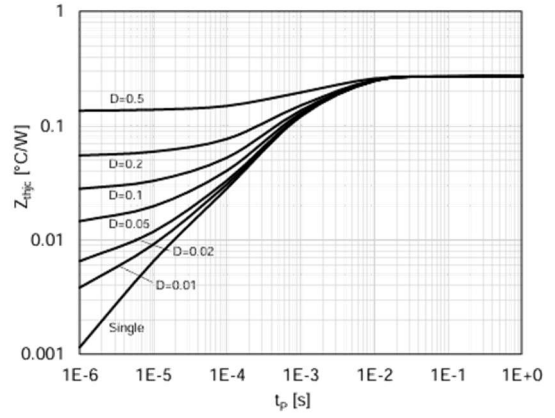
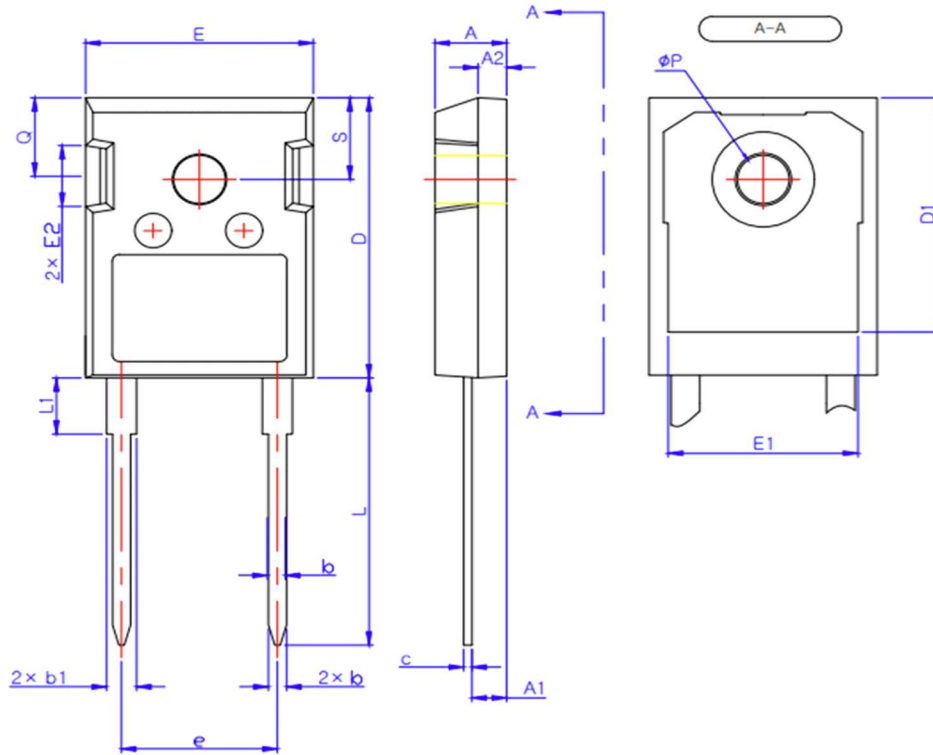

Figure 8. Transient Thermal Response Curve



Package Dimensions:

TO-247-2L



SYMBOL	MIN	MAX
A	4.80	5.20
A1	2.29	2.54
A2	1.90	2.10
b	1.10	1.30
b1	1.91	2.20
c	0.50	0.70
D	20.80	21.34
D1	17.43	17.83
E	15.75	16.13
E1	13.06	13.46
E2	4.32	4.83
e	10.90 BSC	
L	19.85	20.25
L1	-	4.49
phi P	3.55	3.65
Q	5.59	6.19
S	6.15 BSC	

* Dimensions in millimeters