

### RIR120CDM015B

#### 1200V, 15A MPS (Merged PiN Schottky) SiC Diode

##### Features:

- No reverse recovery current
- Low forward voltage
- 175°C Max junction temperature
- High surge current capability
- Fast switching independent of temperature
- Pb-free, halogen free, and RoHS compliant

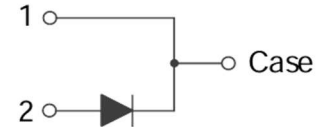
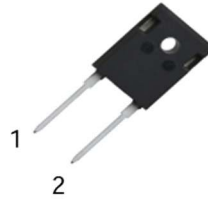

##### Benefits:

- System efficiency improvement
- Higher frequency applicability
- Increased power density
- Reduced cooling effort
- Lower system cost

##### Applications:

- Solar inverter
- EV charging station / OBC
- Power Factor Correction
- Industrial motor drive
- Induction heating / welding

##### Ordering Information

Part Number	Package	Shipping Media	Qualification
RIR120CDM015B	TO-247-2L	30 Units / Tube	Industrial

##### Absolute Maximum Ratings: $T_C = 25^\circ\text{C}$ , unless otherwise specified

Parameter	Symbol	Conditions	Value	Unit
Repetitive peak reverse voltage	$V_{RRM}$		1200	V
Forward current	$I_F$	$T_C = 25^\circ\text{C}$	15	A
Non-repetitive forward surge current	$I_{F,SM}$	$T_C = 25^\circ\text{C}, t_p = 10 \text{ ms}$	106	
		$T_C = 150^\circ\text{C}, t_p = 10 \text{ ms}$	90	
Non-repetitive peak forward current	$I_{F,Max}$	$T_C = 25^\circ\text{C}, t_p = 10 \mu\text{s}$	850	
		$T_C = 150^\circ\text{C}, t_p = 10 \mu\text{s}$	722	
$I^2dt$ value	$\int I^2 dt$	$T_C = 25^\circ\text{C}, t_p = 10 \text{ ms}$	56	$\text{A}^2\text{s}$
		$T_C = 150^\circ\text{C}, t_p = 10 \text{ ms}$	40	
Power dissipation	$P_{tot}$	$T_C = 25^\circ\text{C}$	217	W
Operating and storage temperature	$T_J, T_{STG}$		-55 to +175	$^\circ\text{C}$

### Thermal Characteristics

Parameter	Symbol	Conditions	Value	Unit
Thermal resistance, junction to case, max.	$R_{\theta JC}$		0.69	$^{\circ}\text{C}/\text{W}$

### Electrical Characteristics: $T_C = 25^{\circ}\text{C}$ , unless otherwise specified

Parameter	Sym.	Conditions	Value			Unit
			Min.	Typ.	Max.	
Forward voltage	$V_F$	$I_F = 15\text{A}, T_C = 25^{\circ}\text{C}$		1.39	1.70	V
		$I_F = 15\text{A}, T_C = 175^{\circ}\text{C}$		1.8		
Reverse current	$I_R$	$V_R = 1200\text{V}, T_C = 25^{\circ}\text{C}$			100	$\mu\text{A}$
		$V_R = 1200\text{V}, T_C = 175^{\circ}\text{C}$			300	
Total capacitive charge	$Q_C$	$V_R = 800\text{V}, T_C = 25^{\circ}\text{C}$		92		nC
Total capacitance	C	$V_R = 1\text{V}, f = 100\text{ kHz}$		1010		pF
		$V_R = 800\text{V}, f = 100\text{ kHz}$		65		
Capacitance stored energy	$E_C$	$V_R = 800\text{V}, T_C = 25^{\circ}\text{C}$		26		$\mu\text{J}$

Typical Performance Characteristics:

Figure 1. Power Derating

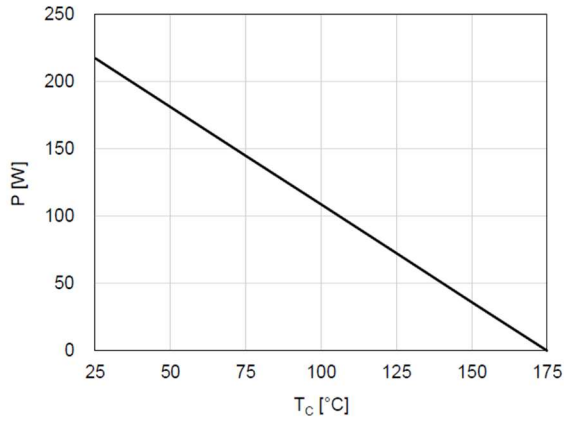

Figure 2. Current Derating

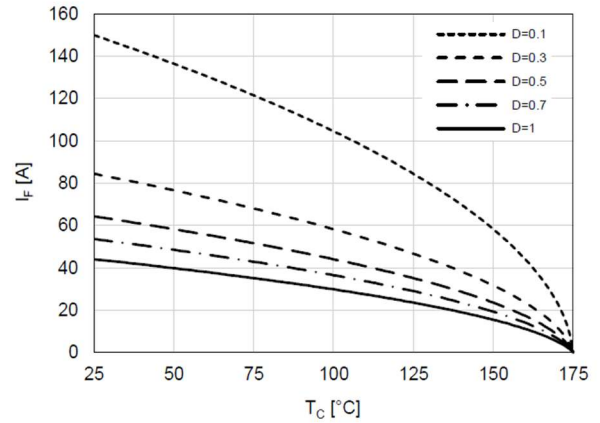

Figure 3. Forward Characteristics

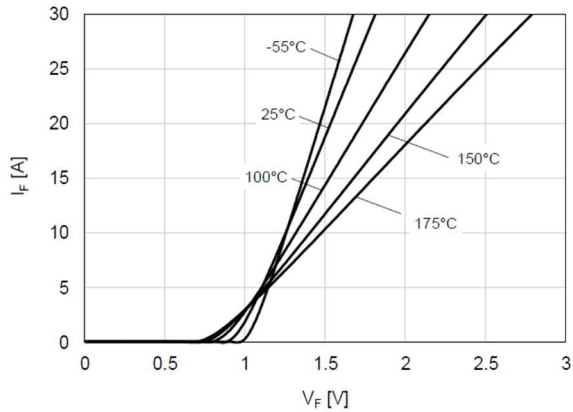

Figure 4. Reverse Characteristics

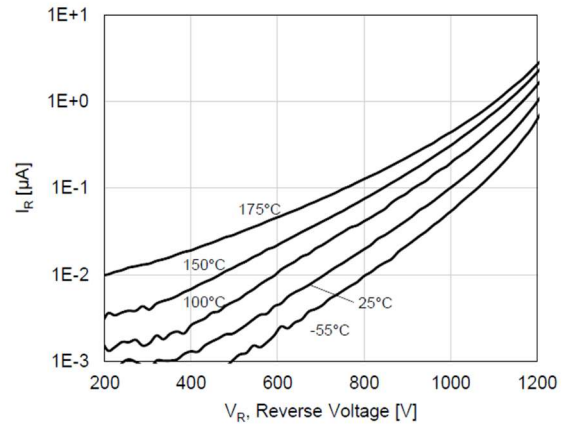

Figure 5. Capacitive Charge Characteristics

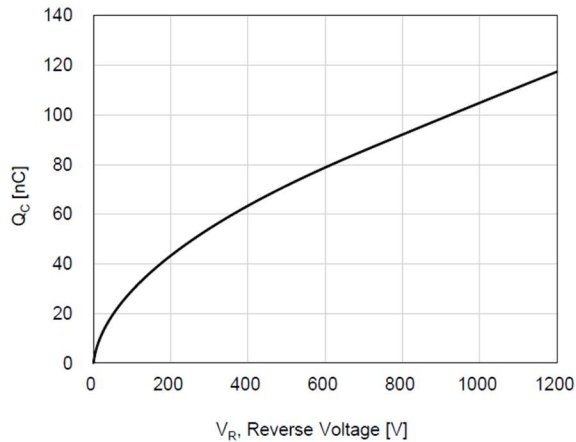

Figure 6. Capacitance Stored Energy

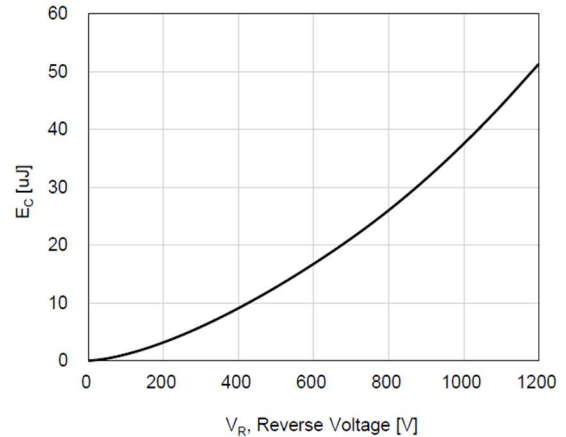

Figure 7. Capacitance Characteristics

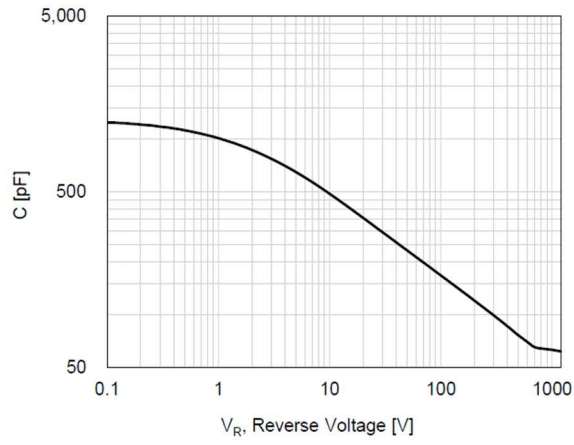
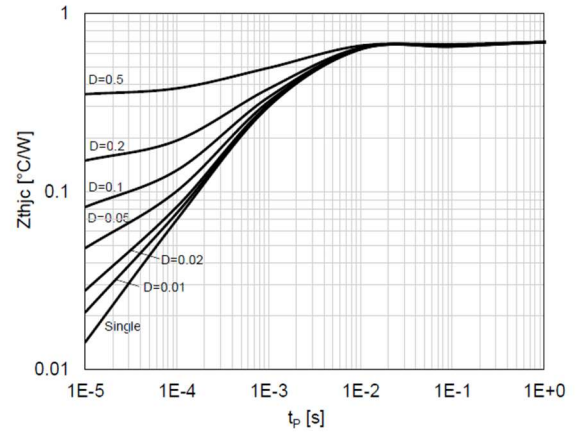
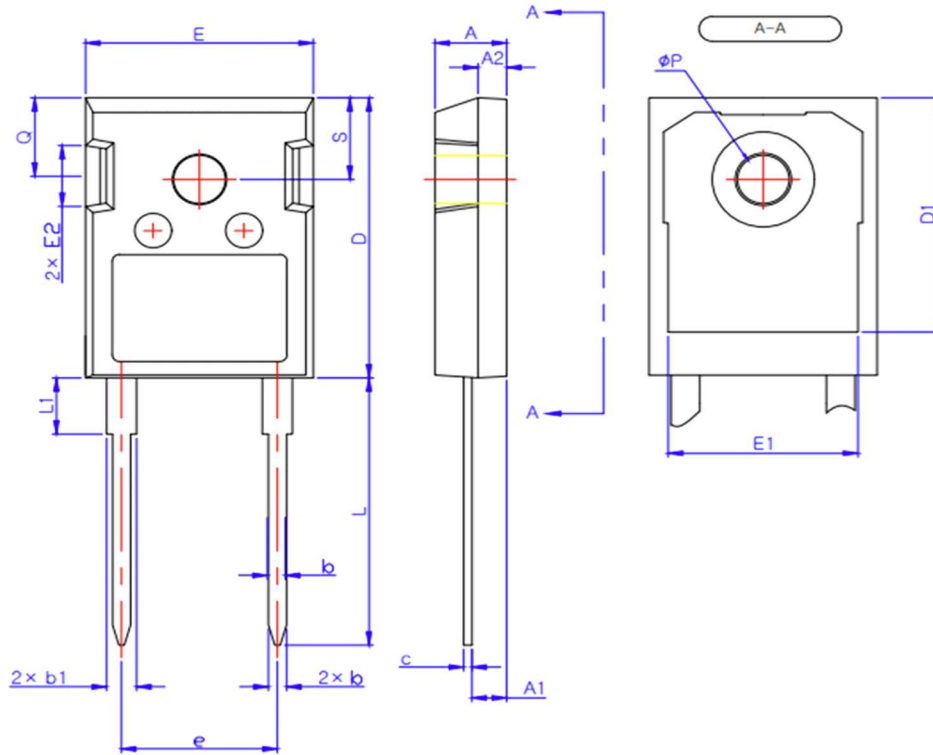

Figure 8. Transient Thermal Response Curve



Package Dimensions:

TO-247-2L



SYMBOL	MIN	MAX
A	4.80	5.20
A1	2.29	2.54
A2	1.90	2.10
b	1.10	1.30
b1	1.91	2.20
c	0.50	0.70
D	20.80	21.34
D1	17.43	17.83
E	15.75	16.13
E1	13.06	13.46
E2	4.32	4.83
e	10.90 BSC	
L	19.85	20.25
L1	-	4.49
phi P	3.55	3.65
Q	5.59	6.19
S	6.15 BSC	

\* Dimensions in millimeters